

EN 54-2
EN 54-4
EN 54-21
EN 12094-1



0051
0051-CPR-1498
0051-CPR-1499

PREVIDIA | COMPACT



ANALOG-ADDRESSABLE FIRE ALARM CONTROL PANEL,
EXTINGUISHANT SYSTEM CONTROL PANEL,
ALARM TRANSMISSION AND FAULT WARNING ROUTING EQUIPMENT

INSTALLATION MANUAL

Warranty

INIM Electronics s.r.l. (Seller, Our, Us) warrants the original purchaser that this product shall be free from defects in materials and workmanship under normal use for a period of 24 months. As INIM Electronics s.r.l. does not install this product directly, and due to the possibility that it may be used with other equipment not approved by Us; INIM Electronics s.r.l. does not warrant against loss of quality, degradation of performance of this product or actual damage that results from the use of products, parts or other replaceable items (such as consumables) that are neither made nor recommended by INIM Electronics. Seller obligation and liability under this warranty is expressly limited to repairing or replacing, at Seller's option, any product not meeting the specifications. In no event shall INIM Electronics s.r.l. be liable to the purchaser or any other person for any loss or damage whether direct or indirect or consequential or incidental, including without limitation, any damages for lost profits, stolen goods, or claims by any other party caused by defective products or otherwise arising from the incorrect or otherwise improper installation or use of this product.

This warranty applies only to defects in parts and workmanship relating to normal use. It does not cover:

- damage arising from improper maintenance or negligence
- damage caused by fire, flood, wind or lightning
- vandalism
- fair wear and tear

INIM Electronics s.r.l. shall, at its option, repair or replace any defective products. Improper use, that is, use for purposes other than those mentioned in this manual will void the warranty. Contact Our authorized dealer, or visit our website for further information regarding this warranty.

Limited warranty

INIM Electronics s.r.l. shall not be liable to the purchaser or any other person for damage arising from improper storage, handling or use of this product.

Installation of this Product must be carried out by qualified persons appointed by INIM Electronics. Installation of this Product must be carried out in accordance with Our instructions in the product manual.

Copyright

The information contained in this document is the sole property of INIM Electronics s.r.l.

No part may be copied without written authorization from INIM Electronics s.r.l.

All rights reserved.

Table of contents

	Warranty.....	2
	Limited warranty.....	2
	Copyright.....	2
	Table of contents	3
Chapter 1	General information	5
1.1	Manufacturer's details	5
1.2	Supplied Documentation	5
1.3	About this manual	5
1.4	Operator classification - Access Levels	6
1.5	CE Mark.....	6
Chapter 2	General Description.....	8
2.1	Previdia Compact Models.....	8
2.2	Control panel descriptions	8
2.3	Fire Extinction.....	12
2.4	Previdia-C-DIAL, telephone line Communicator module	15
2.5	PREVIDIA-C-COM, serial and IP interface module.....	16
2.6	Previdia Compact REP Repeater	17
2.7	Control panels in a Hornet+ network	18
2.8	Control Panels in an IP network.....	18
2.9	Inim Cloud fire	19
Chapter 3	Installation	20
3.1	Mounting the control panel to the wall	20
3.2	Mounting the PREVIDIA-C-DIAL and PREVIDIA-C-COM optional modules.....	21
3.3	Control panel wiring.....	22
3.4	Connecting the "I/O" terminals	24
3.5	Relay output wiring.....	26
3.6	Loop connections.....	27
3.7	Connecting the Hornet+ network.....	27
3.8	Connecting the land-line (PSTN)	28
3.9	Wiring the external communicators	28
	System test.....	31
	Replacement and disposal of used devices.....	31
	WEEE	31

General information

1.1 Manufacturer's details

Manufacturer: INIM ELECTRONICS S.R.L.

Production plant: Centobuchi, via Dei Lavoratori 10

Municipality: 63076, Montepandone (AP), Italy

Tel.: +39 0735 705007

Fax: +39 0735 704912

E-mail: info@inim.biz

Web: www.inim.biz

The personnel authorized by the manufacturer to repair or replace the components of this system have authorization to work only devices marketed under the INIM Electronics brand.

1.2 Supplied Documentation

Previdia Compact User's Manual: contains the identification of the parts on the front plate and the end-user operating instructions for use.

Previdia Compact Installation Manual: contains the technical specifications of the system components, the description of the system applications and use, instructions for the installation of the system components with wiring instructions complete with wiring diagrams for the various modules. contains the instructions for system commissioning.

Manual for system configuration, commissioning and maintenance: contains the instructions for system commissioning and the operations to be carried out during commissioning, maintenance and troubleshooting sessions.

Guide to Networking: contains instructions for the connection of Previdia control panels in a Hornet network or via IP, with the description of the system limits and responsibilities relating to network use.

BMS Manual: provides the installer with the guidelines relating to the integration of Previdia control panels with external supervision systems.

The manuals which are not supplied with the apparatus can be ordered, making reference to their respective codes, or downloaded from www.inim.biz.

1.3 About this manual

Manual code: DCMIIINE0PREVIDIAC

Revision: 1.20

1.3.1 Graphic conventions

Following are the graphic conventions used in this manual.

Conventions	Example	Description
Text in italics	Refer to <i>paragraph 1.3.1 Graphic conventions</i>	Directs you to the title of a chapter, section, paragraph, table or figure in this manual or other published reference.
[Uppercase letter] or [number]	[A] or [1]	Reference relating to a part of the system or video object.

Note: *The notes contain important information relating to the text.*

Attention: *The "Attention" prompts indicate that total or partial disregard of the procedure could damage the device or its peripherals.*

EN54: Such indications indicate that the information and instructions refer to European standards.

Cables: Such indications state the types and specifications of the cables which must be used for the wiring in accordance with the manufacturer's advice or the standard concerned.

1.4 Operator classification - Access Levels

The control panel has 4 distinct access levels:

Level 1: Public level - this is the normal access level of the control panel and is the access level for building inhabitants who are neither authorized to use the system nor instructed in its use.

At this level it is possible to view the information on the display and on the signalling LEDs and interact using the buttons and the touch screen to scroll through the information. Level 1 allows the following operations only:

- mute buzzer
- test signalling LEDs
- activate alarm signalling when an early-warning process is running

Level 2: Authorized users - this access level is for the system supervisors and is for authorized personnel who are adequately instructed in the use of the system and its functions.

Access requires the use of a key or entry of a valid access code with sufficient access rights. In addition to the operations described for level 1 it is also possible to carry out the following operations:

- mute alarm signalling devices
- rearm the control panel
- activate alarm signalling devices manually
- disable control panel elements
- place in test status one or more of the system elements

The system provides two additional sub-levels of authorized user:

- **Superuser level**, like the previous one, with the added possibility of replacing a loop device and registering control panels to their account with the Inim Cloud service
- **Maintenance operator level**, same as the previous level with the added possibility of stopping the valve pulse for those models that support extinction functions

Level 3: Programming - this access level is for specialized technical operators who carry out system configuration, commissioning and maintenance.

Access requires entry of a valid access code with sufficient access rights after inserting a jumper which enables programming. Refer to the manual for system configuration, commissioning and maintenance.

ONLY authorized technicians, appointed by the Manufacturer can, by means of special tools, carry out repair work on the motherboard.

Level 4: ONLY authorized technicians, appointed by the Manufacturer can, by means of special tools, carry out repair work on the motherboard.

1.5 CE Mark

1.5.1 Regulation (EU) No. 305/2011

This product complies with requirements stated by standards listed here below in compliance with Regulation (EU) No. 305/2011.

 0051
INIM Electronics s.r.l. Via Dei Laboratori 10 - Fraz. Centobuchi 63076, Montepandone (AP) - Italy
18 0051-CPR-1498
EN 54-2:1997 + A1:2006 EN 54-4:1997 + A1:2002 + A2:2006 EN 54-21:2006 EN 12094-1:2003
PREVIDIA-C200LG, PREVIDIA-C200LR, PREVIDIA-C200LZG, PREVIDIA-C200LZR, PREVIDIA-C200LZEG, PREVIDIA-C200LZER
<i>Control and indicating equipment with power supply equipment, alarm transmission and fault warning routing equipment and electrical automatic control and delay device integrated for fire detection and fire alarm systems installed in buildings and for gas extinguishing systems installed in buildings and part of a complete system.</i>

 0051
INIM Electronics s.r.l. Via Dei Laboratori 10 - Fraz. Centobuchi 63076, Montepandone (AP) - Italy
18 0051-CPR-1499
EN 54-2:1997 + A1:2006 EN 54-4:1997 + A1:2002 + A2:2006 EN 54-21:2006 EN 12094-1:2003
PREVIDIA-C050SG, PREVIDIA-C050SR, PREVIDIA-C050SZG, PREVIDIA-C050SZR, PREVIDIA-C050SZEZ, PREVIDIA-C050SZER, PREVIDIA-C100SG, PREVIDIA-C100SR, PREVIDIA-C100SZG, PREVIDIA-C100SZR, PREVIDIA-C100SZEZ, PREVIDIA-C100SZER, PREVIDIA-C200SG, PREVIDIA-C200SR, PREVIDIA-C200SZG, PREVIDIA-C200SZR, PREVIDIA-C200SZEZ, PREVIDIA-C200SZER
<i>Control and indicating equipment with power supply equipment, alarm transmission and fault warning routing equipment and electrical automatic control and delay device integrated for fire detection and fire alarm systems installed in buildings and for gas extinguishing systems installed in buildings and part of a complete system.</i>

Performance in the event of fire	PASS	
Power supply performance	PASS	
Response delay (response time in the event of fire)	PASS	
Transmission performance	PASS	
Operating reliability	PASS	
Durability of operating reliability:	Thermal resistance	PASS
	Vibration resistance	PASS
	Humidity resistance	PASS
	Electrical stability	PASS
Options provided in accordance with EN54-2		Performance
7.8 Output to fire alarm devices	PASS	
7.9 Output to fire alarm routing equipment	PASS	
7.10 Output to fire protection equipment	PASS	
7.11 Delay on outputs	PASS	
7.12 Co-incident detection (Type A, B and C)	PASS	
7.13 Alarm counter	PASS	
8.3 Point fault signal	PASS	
8.9 Output to remote fault or warning signalling devices	PASS	
9.5 Addressable points out-of-service	PASS	
10.0 Test condition	PASS	
Options provided in accordance with EN12094-1		Performance
4.17 Delay of extinguishing signal	PASS	
4.18 Signal representing the flow of extinguishing agent	PASS	
4.19 Monitoring of the status of components	PASS	
4.20 Emergency hold device (*)	PASS	
4.21 Control of flooding time	PASS	
4.23 Manual only mode	PASS	
4.24 Triggering signals to equipment within the system	PASS	
4.26 Triggering of equipment outside the system	PASS	
4.27 Emergency abort device (*)	PASS	
4.30 Activation of alarm devices with diverse signals	PASS	
(*) one only between 4.20 and 4.27		
Additional information according to EN 54-2		
About information required at point 12.2.1, see data contained in this manual.		
Additional information according to EN 54-4		
For the information required by point 7.1, see data contained in this manual.		
Additional information according to EN 54-21		
For the information required by point 7.2.1, see data contained in this manual.		
Additional information according to EN 12094-1		
Environmental class: A		
Degree of protection: IP30		
Flooding zones: 1		
Zones for CO ₂ , inert gas or halogenated hydrocarbons.		
Response delay activation condition: max 3s		
Response delay triggering of outputs: max 1s		

1.5.2 Directive 2014/53/EU

Hereby, INIM Electronics S.r.l. declares that these Previdia Compact are in compliance with the essential requirements and other relevant provisions of Directive 2014/53/EU.

Following paragraph explains how to download the complete Declaration of Conformity.

This product may be used in all EU Countries.

1.5.3 Documents for the users

Declarations of Performance, Declarations of Conformity and Certificates concerning to INIM Electronics S.r.l. products may be downloaded free of charge from the web address www.inim.biz, getting access to Extended Access and then selecting "Certifications" or requested to the e-mail address info@inim.biz or requested by ordinary mail to the address shown in *paragrafo 1.5.1*.

Manuals may be downloaded free of charge from the web address www.inim.biz, getting access to Extended Access and then selecting "Manuals".

General Description

2.1 Previdia Compact Models

Previdia Compact is a series of control panels for the management of fire detection and extinguishing systems.

This series provides different models of control panels distinguished by certain technical characteristics such as the number of loops and devices that can be managed, the type of cabinet in which the modules are housed, the presence of signalling LEDs on the front plate and the possibility of managing an extinction channel.

The name of each model specifies its characteristics, in accordance with the following table:

Series prefix	Number of loops		Mounting cabinet size		Zone LEDs		Extinction channel		Cabinet colour	
PREVIDIA-C	200	2 loops of 240 points	S	small cabinet	Z	Available LED indicators	E	Discharge zone	G	grey
	100	1 loops of 240 points	L	large cabinet	-	LED indicators not available	-	Extinction not available	R	red
	050	1 loops of 64 points								

2.2 Control panel descriptions

Each control panel model comes in a metal cabinet that is packed in a cardboard box. The cabinets used for the Previdia Compact series differ in size and colour:

- **small cabinet**, dimensions 325x325x80mm, capacity to house 2 batteries of 1,5A – 7Ah, in light grey or red
- **large cabinet**, dimensions 497x380x87mm., capacity to house 2 batteries of 4A – 7Ah, in light grey or red

Installed inside:

- CPU unit with 4.3" touchscreen, buttons and LEDs for the user interface
- I/O unit for loop management, Hornet+ network and input/output terminals
- power supply module
- batteries, not included

In Some versions there is also a signalling module with 30 individually programmable indicator LEDs (three colours).

The modules can be installed in all the control panels in the range:

- PREVIDIA-C-DIAL (communicator module for communications over PSTN or GSM networks and the management of GPRS connections)
- PREVIDIA-C-COM (serial and IP interface module)

Supplied with the control panel is a plastic bag containing:

- battery connection wires
- ring terminal for the earth connection
- Keys for the selection of access level 2
- resistors and EOL diodes for the supervised circuits
- Installation manual

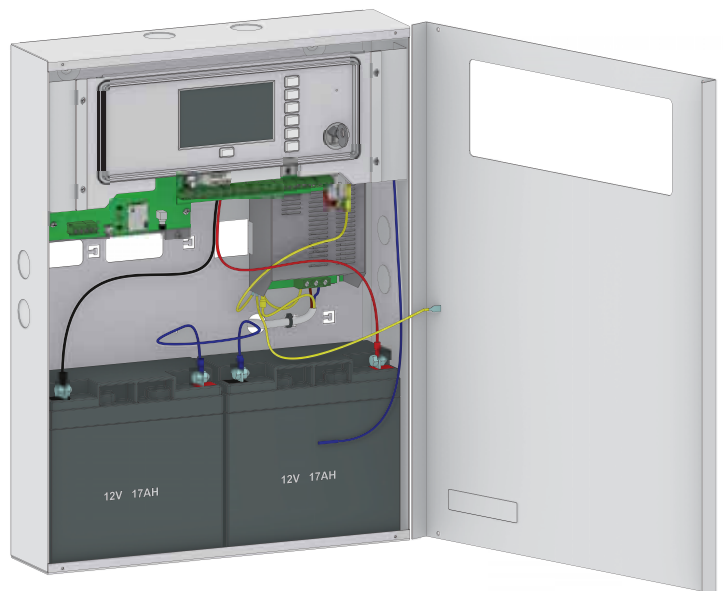

Note: *The control panels described in this manual have been designed and manufactured to the highest standards of quality, reliability and performance adopted by INIM Electronics. The components selected for this product will operate properly within their specifications when the environmental conditions outside the product enclosure comply with Class 3k5 (EN 60721-3-3).*

EN54: *The gas detection function is not provided for in the aforesaid standard and therefore cannot be considered EN54-2 compliant.*

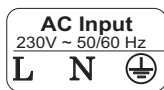
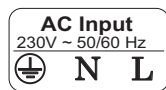
Specification	Previdia Compact Models	
	PREVIDIA-CxxxS (in small cabinet)	PREVIDIA-CxxxL (in large cabinet)
Supply voltage	230V~ (-15% / +10%) 50/60Hz	
Maximum current draw 230V	0.5 A	1.1 A
AC mains input terminals		
Nominal output voltage	27.6 V $\overline{\text{---}}$	
Maximum output current	1.5 A	4 A
$I_{\text{max. a}}$	1.5 A	4 A
$I_{\text{max. b}}$	1.5 A	4 A
Motherboard absorption	stand-by	150mA
	without supply voltage	130mA
	LED test	170mA
LED board absorption (where present)	stand-by	5mA
	LED test	115mA
Maximum battery-charge current	0.6 A	1.2 A
Battery specifications	2 x 12 V, 7 Ah	2 x 12 V, 17 Ah
	with UL94-V2 flame class casing or higher	
Maximum internal resistance of batteries ($R_{i \text{ max}}$)	2.7 Ohm	1 Ohm
Output voltage	from 19 to 27.6V	
Battery shutdown tension	19V	
Internal fuse of power supply module	T 3.15A 250V	
Maximum output current ripple	420 mV	260 mV
Operating temperature	from -5°C to 40°C	
Isolation class	I	
Enclosure protection class (EN 60529)	IP30	
Dimensions	322 x 324 x 86 mm	497 x 380 x 97 mm
Weight (without batteries)	3.3 Kg	6.1 Kg

When you remove the four screws and metal-front plate, you will find:

[A]	Touchscreen display
[B]	Status LED
[C]	LED and function button
[D]	LED and multiple-alarm button
[E]	Access-key slot
[F]	Buzzer
[G]	MicroSD card holder
[H]	Reset button
[I]	Button to reset default settings (factory settings)
[J]	Programming jumper connector
[K]	Ethernet port
[L]	Mini USB port
[M]	Connector for PREVIDIA-C-DIAL board
[N]	Connector for PREVIDIA-C-COM board
[O]	Support for the motherboard
[P]	Support anchor screw
[Q]	Terminal board
[R]	Power-supply terminals
[S]	Earthing point
[T]	Front plate earth wire
[U]	Battery wires
[V]	Thermal probe for batteries
[W]	Cable entry
[X]	Locations for the mounting screws of the optional plate
[Y]	Mounting screw locations
[Z]	Locations for the front plate screws
[A1]	Battery housing

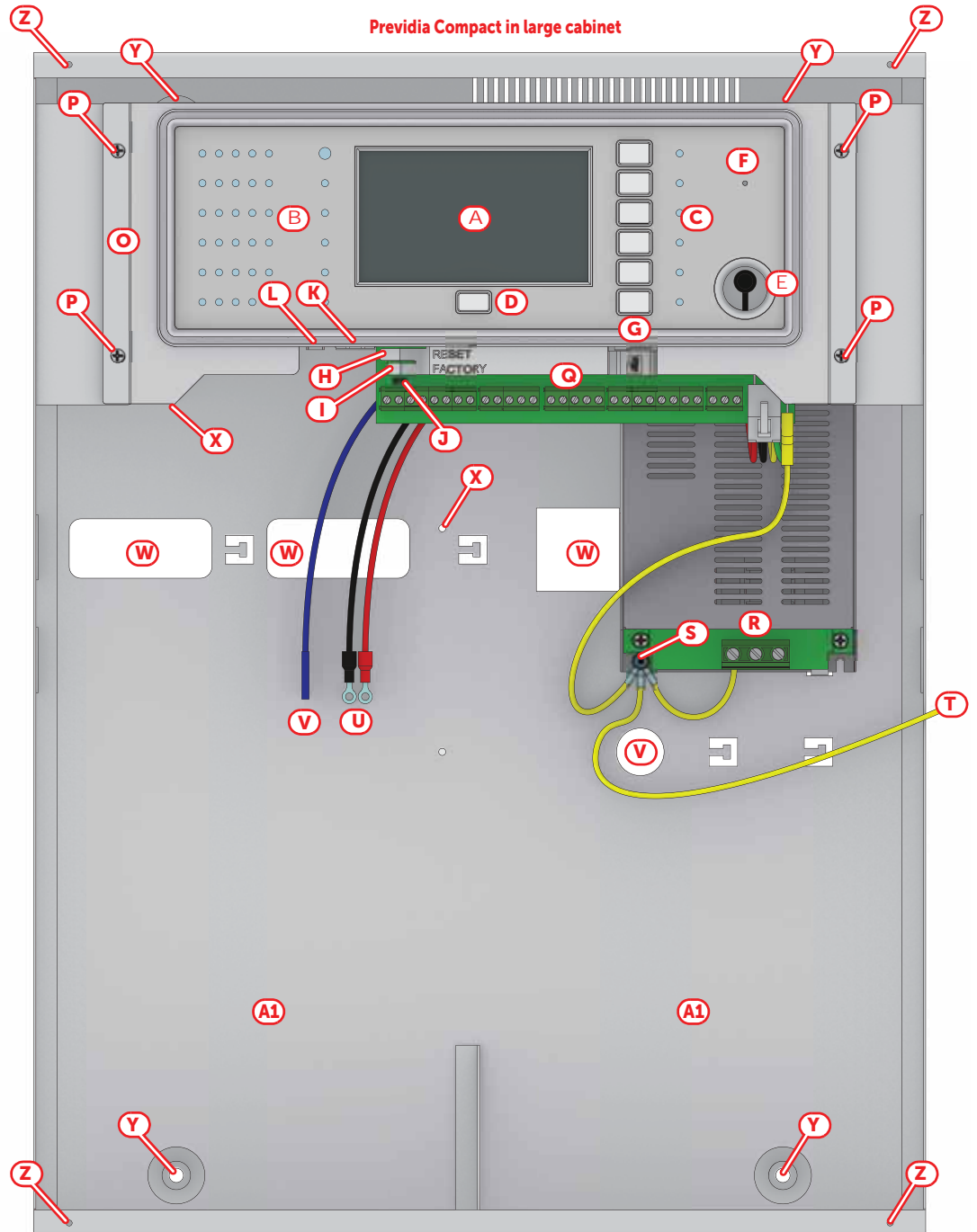

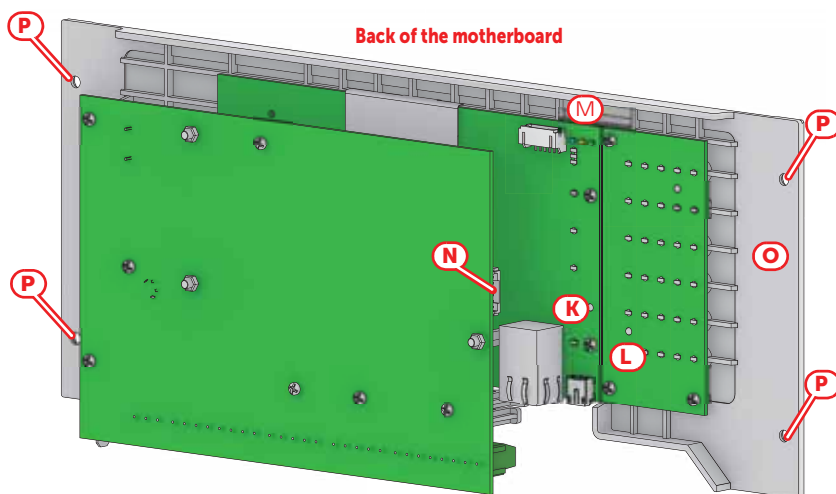
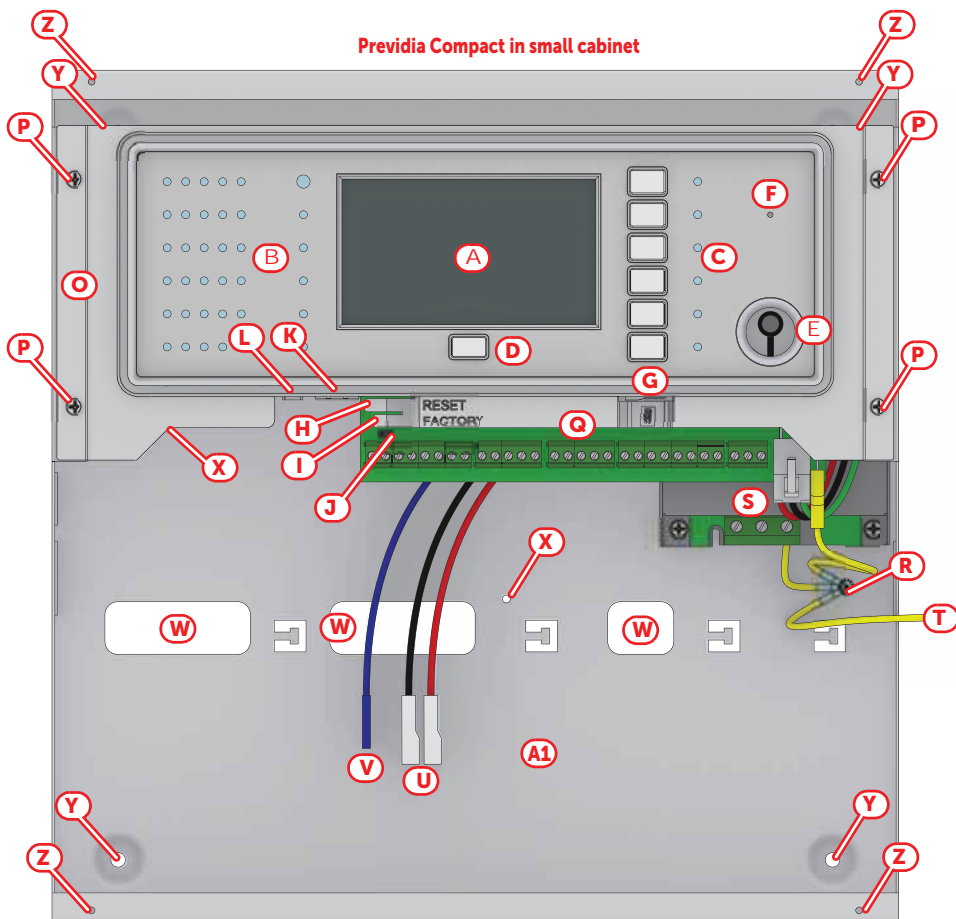

Output connection terminals

number	name	maximum current:	function
1, 5	+24	500mA	Positive
2, 3	A+, A-	/	Hornet+ network terminal
6, 7	B+, B-	/	
4, 8	-	/	







Output connection terminals

number	name	maximum current:	function	
9, 10	+ L1.O -	500mA	Terminals of loop 1	Output
12, 13	+ L1.I -			Input
14, 15	+ L2.O -	500mA	Terminals of loop 2	Output
17, 18	+ L2.I -			Input
11, 16		/	Earth terminal	
19, 20	+ I/O1 -	1A @ 27.6V	Input/Output connection terminals	
21, 22	+ I/O2 -	1A @ 27.6V		
23, 24	+ I/O3 -	1A @ 27.6V		
25, 26	+ I/O4 -	1A @ 27.6V		
27, 28, 29	NO, C, NC	5A @ 30V	Free voltage relay	

2.3 Fire Extinction

Some models of Previdia Compact control panel allow the management of a gas-extinguishing channel.

Complies with EN12094-1 and provides the inputs, outputs and control logic required by these systems.

LED	Colour	On solid	Flashing
 Extinction channel activation LED	Red	Discharge activated	Pre-extinction condition running
 Automatic activation indicator LED	Red	Automatic discharge command activated	Automatic discharge command partially activated
 Bypass automatic activation LED	Yellow	The automatic discharge command has been bypassed	/
 Bypass extinction channel LED	Yellow	Channel bypassed	/
 Manual stop extinction LED	Yellow	Stop extinction command activated	Fault on stop-extinction circuit
 Stop extinction LED from non-electrical-devices	Yellow	Stop extinction command activated	Fault on stop-extinction circuit

The following figure shows a flowchart of the operations carried out by the control panel in the pre-extinction phase, that is, from the occurrence of the events that trigger the extinction phase to the start of the release condition, and during the release of fire extinguishing gas:

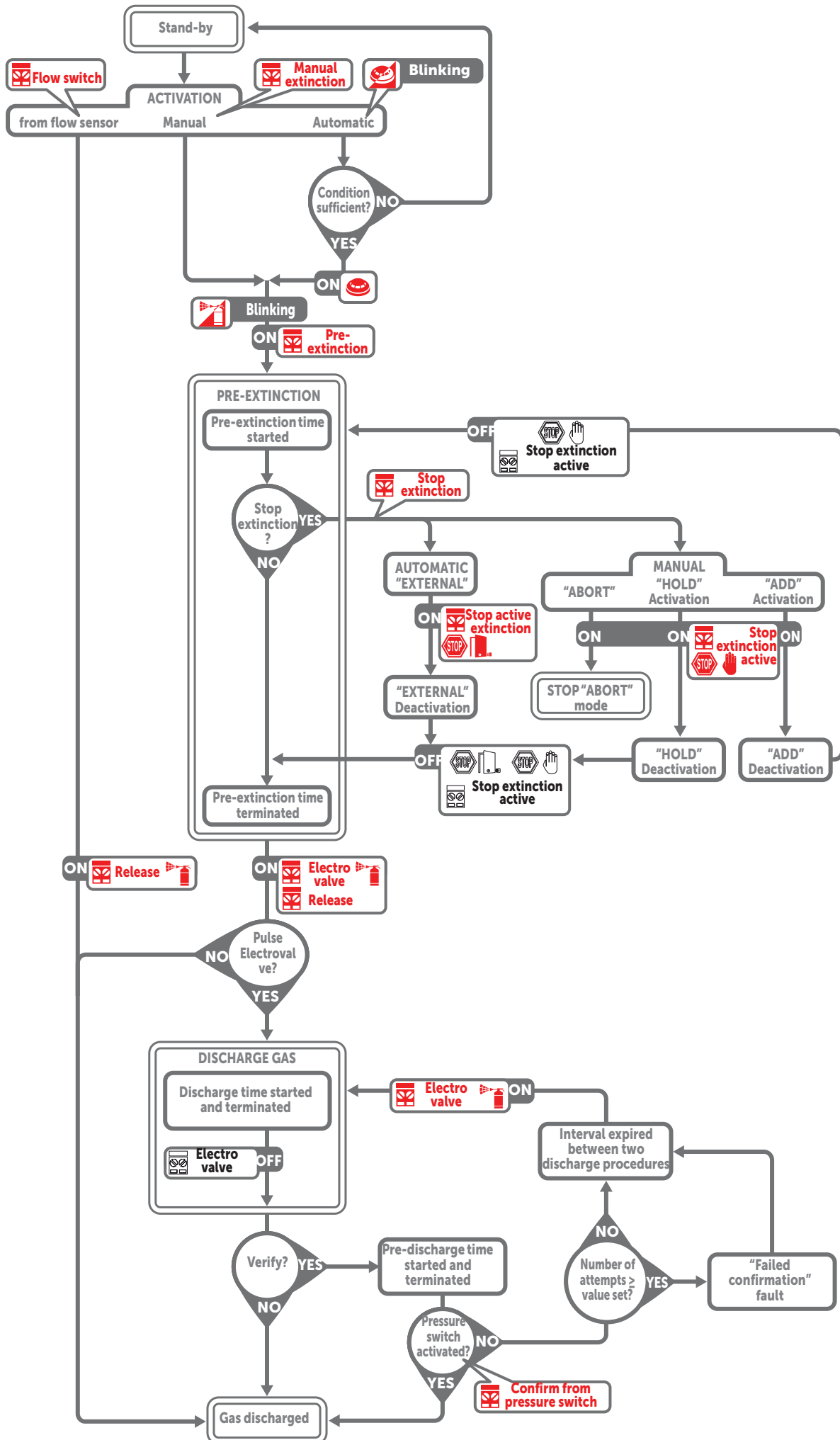

The following table contains a description of the functions associated with the extinction that can be programmed for the control panel inputs and outputs (on-board or on loops, through supervised outputs, such as those of the EM312SR modules).

Terminal function		Activation	
Pressure switch	Input for the supervision of the pressure of the cylinders containing the gas.	The input is activated in the case of pressure drop in the cylinders. During stand-by status, its activation generates a fault warning.	
Confirm release from pressure switch	Input, for the connection of a pressure switch, confirming the release of the gas from the cylinders.	After releasing the electrovalve, its activation is used to confirm the release of the gas.	
Flow switch	Input, for the connection of a flow sensor that will signal the release of the gas from the cylinders.	The input will be activated by a sensor that detects the flow of extinguishing gas. The flow may have been activated directly without following the procedure of extinction and pre-extinction.	
Stop extinction	The inputs stop the extinction procedure in accordance with the activation mode described opposite.	Abort	If this input is activated during the pre-extinction phase, the extinction procedure will be aborted even if the input resets. The procedure can be restarted only after control panel reset. If this input is activated during stand-by, it will generate a fault warning.
		Add	If this input activated during pre-extinction status, the extinction procedure will remain locked until the input resets. On input reset the pre-extinction countdown will refresh and restart. If this input is activated during stand-by, it will generate a fault warning.
		Hold	If activated during a pre-extinction condition, the extinction procedure is stopped but the pre-extinction time count continues. When the input is restored, if the pre-extinction time count has terminated, the gas will be released. If this input is activated during stand-by, it will generate a fault warning.
		External	This function is identical to the "Hold" function but refers to mechanical or electrical intervention (for example, a door contact that inhibits gas discharge, etc.). This activation will be signalled separately. If activated during stand-by, it will not generate a fault warning.
Manual extinction	This input is for the connection of one or more manual call points for the activation of extinguishing-agent discharge.		
Electrovalve	Output for the connection of the electrovalve which discharges the extinguishing agent.	It will activate only when the pre-extinction time expires	
Stop extinction active	Output for the connection of stop-extinction signalling devices.	It will activate when the extinction channel is stopped by one or more inputs connected to the "Stop extinction" input.	
Pre-extinction	Output for the connection of a signal relating to imminent discharge of the extinguishing agent.	It will activate during the pre-extinction time which runs before the discharge of the extinguishing agent.	
Release	Output for the connection of signalling devices which warn building inhabitants of the actual discharge of the extinguishing agent.	It will activate on activation of the electrovalve.	

EN12094-1: To guarantee compliance of the product to EN 12094-1, the control panel must be configured to make available the following functions (the others are optional):
 Manual extinction, Electrovalve, Pre-extinction, Release.
 The "Electrovalve" function must only be associated with the "I/O4" terminal on board the control panel.
 The "Pre-Extinction" function at default is associated with the terminal "I/O3" on board the control panel.

Refer to the Configuration Manual for the programming details of the other functions.

EN12094-1: In compliance with the requirements of standard EN 12094-1, if the "Stop extinction-Abort" function is used in a Previdia Compact control panel, the "Stop Extinction-Hold" and "Stop Extinction-Add" functions cannot be activated, and vice versa.
Please remember that no more than 32 devices can be connected to each of the selected input or output terminals.

2.4 Previdia-C-DIAL, telephone line Communicator module

The optional Previdia-C-DIAL board allows you to connect Previdia Compact control panels to the landline (PSTN) and to the GSM 2G and 3G networks.

It manages reporting protocols used by alarm receiving centres. This module allows the control panel to make voice calls and send SMS text messages.

The board comes with:

- Mounting plate
- 7 mounting screws
- cable for the connection to the motherboard
- remote antenna
- Instructions manual

SIM card not included

[A]	Motherboard connector		
[B]		Ground terminal	
	L.E.	Telephone line connection terminals	
	L.I.	Internal telephone line terminals	
[C]	Mini USB port		
[D]	Reset button		
[E]	Button to reset default settings (factory settings)		
[F]	SIM card holder		
[G]	GSM antenna connector		
[H]	Screws for fixing the board to the plate		
[I]	Mounting plate		
[J]	Hole for the mounting plate screw		

Technical specifications

Supply voltage		19-30 V $\overline{---}$
Consumption @ 27.6V	stand-by	40mA
	maximum	140mA
Band frequency		2G: 850/900, 1800/1900 MHz 3G: 800/850/900, 1900/2100 MHz
Maximum RF output power		2W @ 1W
Operating temperature		from -5°C to +40°C
Antenna		remote GSM-UMTS cable 2m, SMA-Male connector (50Ohm impedance) and magnetic base

2.5 PREVIDIA-C-COM, serial and IP interface module

The PREVIDIA-C-COM optional board, available in two models, allows the Previdia Compact to interface with third-party devices external to the control panel.

The communication channels and functions connected to them depend on the model of the board:

- two RS485 channels
- two RS232 channels
- a LAN channel via ethernet port, only for the PREVIDIA-C-COM-LAN model

The PREVIDIA-C-COM-LAN model also provides the control panel with the functions of video verification, e-mail transmission, web server and use of BACnet protocol.

The board comes with:

- Mounting plate
- 7 mounting screws
- 5 spacers
- cable for the connection to the motherboard
- Instructions manual

SD card not included

[A]	Motherboard connector		
[B]	Terminals RS485-1		
[C]	Terminals RS485-2		
[D]	Terminals RS232-1		
[E]	Terminals RS232-2		
[F]	Connectors for RS485-1 EOL resistance		
[G]	Connectors for RS485-2 EOL resistance		
[H]	MicroSD card holder		
[I]	Ethernet port		for PREVIDIA-C-COM-LAN only
[J]	Reset button		
[K]	Button to reset default settings (factory settings)		
[L]	Hole for screw fixing the board to the plate		

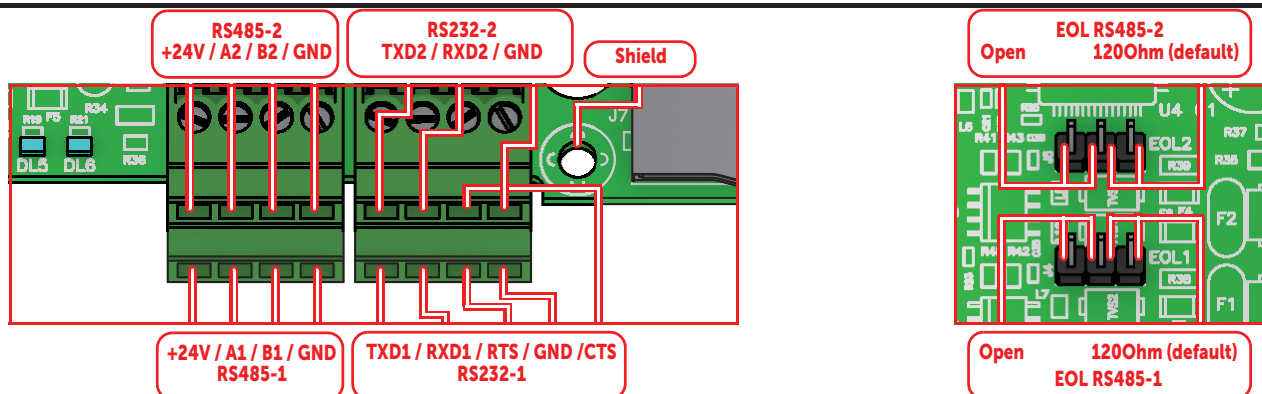

Technical specifications	PREVIDIA-C-COM	PREVIDIA-C-COM-LAN
Supply voltage	19-30 V _{DC}	
Consumption @ 27.6V	15mA	40mA
I _{max} . RS485	200mA	
Operating temperature	from -5°C to +40°C	
SD card capacity	/	Maximum 32 Gbyte

2.6 Previdia Compact REP Repeater

For installations requiring a system control point other than the point where the Previdia Compact control panel is installed, there are two repeater panel models, that is, devices that allow you to remotely view the information available on the user interface of the control panel.

The models are:

- PREVIDIA-C-REP, standard repeater
- PREVIDIA-C-REPE, standard repeater with extinction channel LEDs

[A]	Touchscreen display	[H]	Ethernet port
[B]	Status LED	[I]	Mini USB port
[C]	LED and function button	[J]	Terminal board
[D]	LED and multiple-alarm button	[K]	Backlocking grips
[E]	Access-key slot	[L]	Cable entry
[F]	Buzzer	[M]	Mounting screw locations
[G]	MicroSD card holder	[H]	Ethernet port

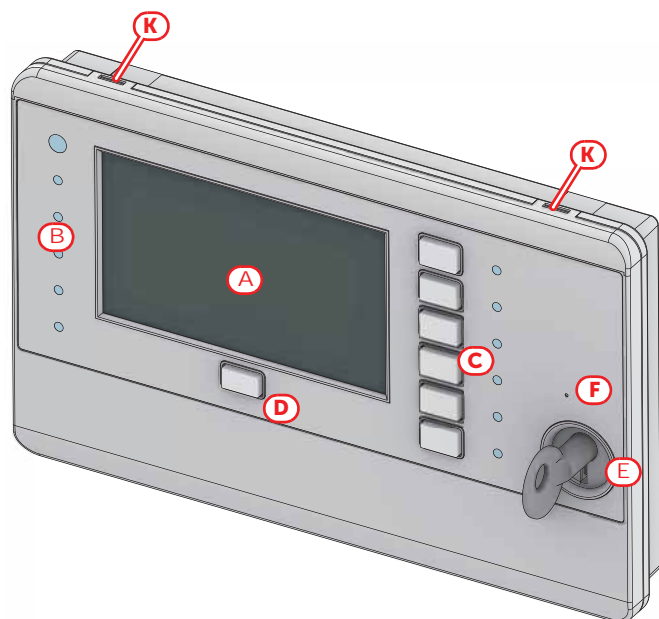
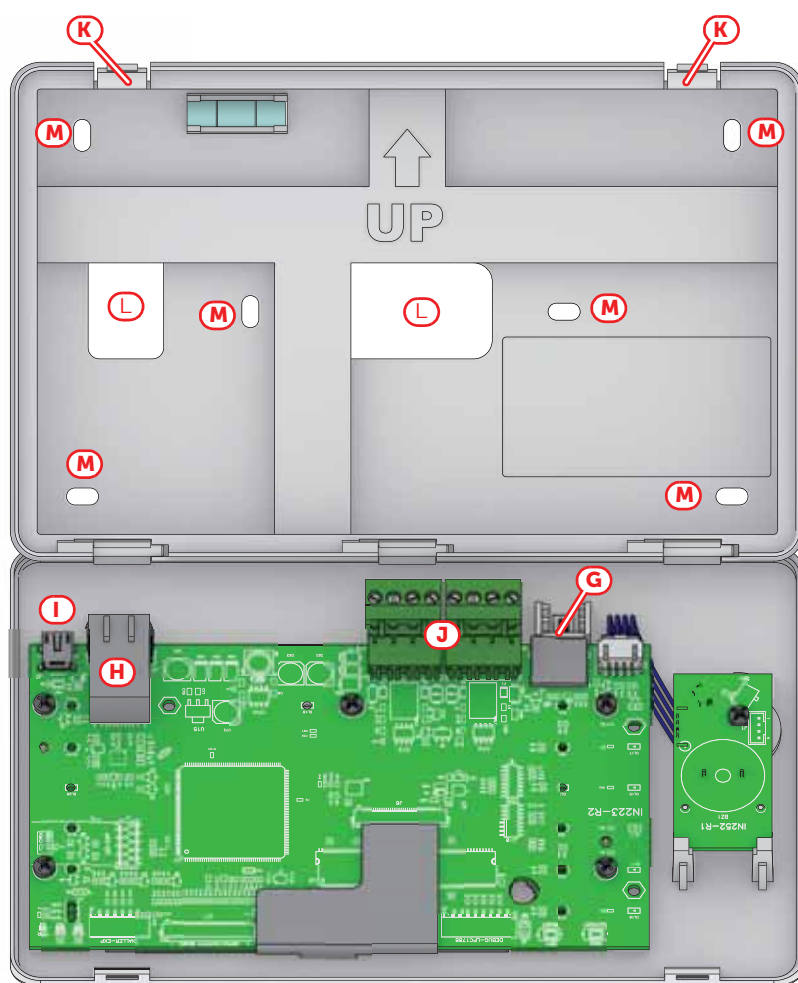

Technical specifications

Supply voltage		19-30 V $\overline{\text{---}}$
Consumption @ 27.6V	stand-by	110mA
	during mains failure	80mA
	maximum	130mA
Operating temperature		from -5°C to +40°C
Dimensions		210 x 132 x 32mm
Weight		330g

The repeaters can be connected to the system via the Hornet+ network (*paragraph 3.7 Connecting the Hornet+ network*) or via a TCP-IP connection and can also be associated with Previdia Max control panels.

If necessary, it is possible to power the repeater using an external power supply module.

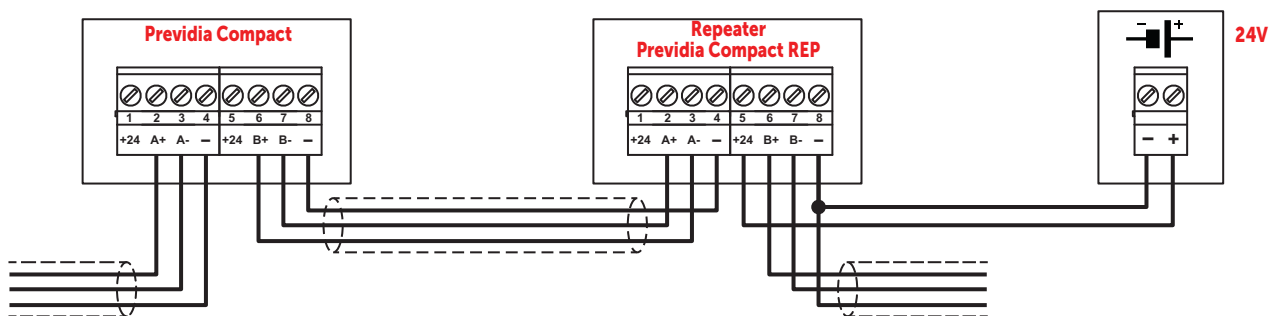

EN54: The power-supply unit employed must be EN54-4 standard compliant.

2.7 Control panels in a Hornet+ network



In order to enlarge the installation, it is possible to connect several Previdia Max and Previdia Compact control panels (with a maximum of 48 points including control panels and repeaters) thus creating an expanded system (Hornet+ network).

Each model of the Previdia Compact control panel provides two RS485 ports for the ring connection (for details on the wiring refer to *paragraph 3.7 Connecting the Hornet+ network*).

For further information regarding the method used for connecting control panels in a network refer to the Previdia Networking Guide available at www.inim.biz

2.8 Control Panels in an IP network

Several Previdia-Max and Previdia Compact control panels or more Hornet+ control panel networks can be connected to each other via a TCP-IP connection.

Each node in a connection of this type is identified as a "cluster". Each cluster can consist of a single control panel, a Hornet+ network of control panels or a repeater.

For further information regarding the method used for connecting control panels in a network refer to the Networking Guide available at www.inim.biz

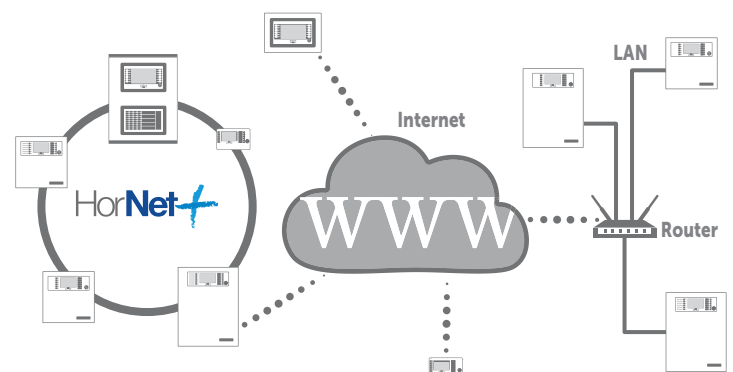

2.9 Inim Cloud fire

The INIM Electronics Cloud service provides Previdia users with an additional way of managing control panels via the Internet.

The connection of control panels to the Cloud service is achieved via a web interface (App or any browser) without any need to configure the network on which the control panel is installed. In particular, it is not necessary to program a router to perform port-forwarding and the like in order to reach the control panel.



Each cluster can be connected to the Inim Cloud, thus allowing you to take advantage of the following features:

- Remote system monitoring (thus overcoming local network configuration difficulties)
- System register management (in accordance with local regulations)
- Management of the maintenance register

Chapter 3

Installation

Note: *The installation of these control panels must be carried out in full compliance with the local fire regulations, the laws and regulations in force, and in accordance with the instructions and relevant guidelines.*

This Fire control panel should be located in a place that is:

- Dry
- Far from electromagnetic interference (electrical equipment, heating units, air-conditioning units, radio transmitters, etc.)

The mounting location must satisfy all the requirements of the respective laws and bylaws in force for technical installations.

The system must be installed in accordance with the following procedure:

1. Lay the cables
2. Connect all the devices to the BUS and to the loops.
3. Mount the Previdia-C-DIAL module inside the control panel (optional).
4. Mount the control panel to the wall
5. Complete the connections inside the control panel.
6. Power up the system.
7. Test the system

EN54: In order to guarantee the IMQ-safety systems certification and compliance to standard EN54-2:

- all the manual alarm buttons and fire detectors employed in the system must be associated with fire detection and alarm functions.
- not more 512 detectors and/or manual call points can be connected.
- the wiring must be such that, in the event of any failure, the number of devices that remain insulated can never exceed 32.

3.1 Mounting the control panel to the wall

1. Remove the securing screws and door (*paragraph 2.2 - [Z]*).
2. Remove the screws of the plastic housing containing the motherboard (*paragraph 2.2 - [O]*) paying attention to the power-supply connection cables.
3. Open the holes at the side that you intend to use for the cable passage.

Note: *In order to guarantee the IP30 protection grade, do not open any other holes..*

4. Pull the cables through the open cable entries.
5. Using the holes on the back, mount the cabinet to the wall (*paragraph 2.2 - [Y]*).
The manufacturer strongly recommends the use of 8mm diameter minimum anchor screws (stop screws).
6. Complete the connections with the control panel terminals.
7. Replace the front plate.

3.2 Mounting the PREVIDIA-C-DIAL and PREVIDIA-C-COM optional modules

The PREVIDIA-C-DIAL and PREVIDIA-C-COM modules must be mounted inside the cabinet.

Attention: *The module installation procedure must be carried out after disconnecting the control panel power supply (220V and batteries).*



If only one of the optional modules is to be installed, the procedure to be followed is as follows:

1. Open the control panel cabinet by removing the metal front plate and the plastic support of the motherboard (paragraph 2.2 - [O]).
2. Attach the mounting plate to the back of the cabinet by fastening the screws provided into the appropriate holes ([A], paragraph 2.2 - [X], paragraph 2.4 - [J]).
3. Attach the board to the mounting plate by fastening the screws provided into the appropriate holes ([B], paragraph 2.4 - [H] and paragraph 2.5 - [L]).
4. Using the cable supplied, connect the module to the motherboard via the appropriate connectors (paragraph 2.2 - [M] and paragraph 2.4 - [A] for PREVIDIA-C-DIAL, and paragraph 2.2 - [N] and paragraph 2.5 - [A] for PREVIDIA-C-COM).
5. Complete the external connections.
6. Replace the plastic support and replace the lid+.

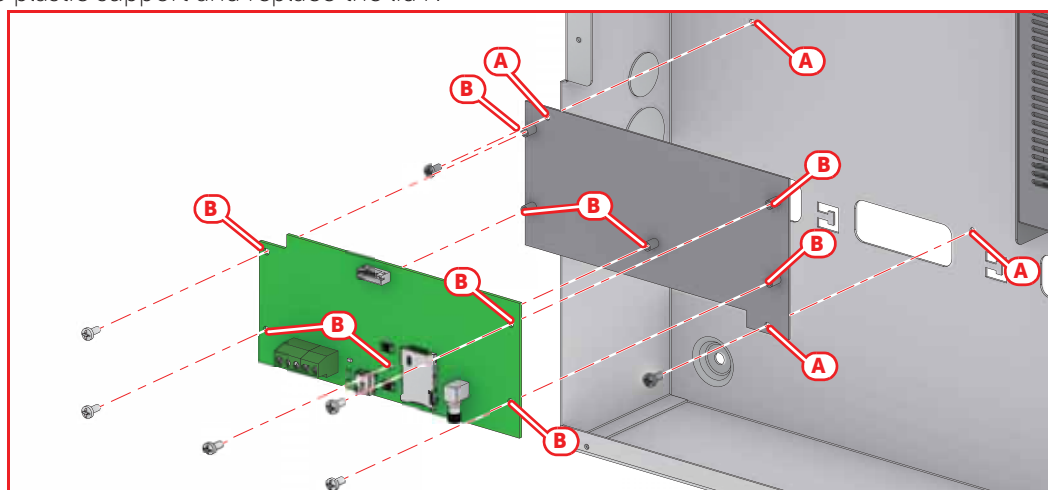

If both optional modules are to be installed, work through the following procedure:

1. Mount the PREVIDIA-C-DIAL module on the back of the cabinet following the procedure described above.
2. Attach the spacers supplied with the PREVIDIA-C-COM module to the mounting holes of the PREVIDIA-C-DIAL module ([C], paragraph 2.4 - [J]).
3. Attach the PREVIDIA-C-COM module to the spacers by fastening the screws provided into the appropriate holes ([D] paragraph 2.5 - [L]).
4. Using the cable supplied, connect the module to the motherboard via the appropriate connectors (paragraph 2.2 - [N] and paragraph 2.5 - [A]).
5. Complete the external connections.

6. Replace the plastic support and replace the lid.

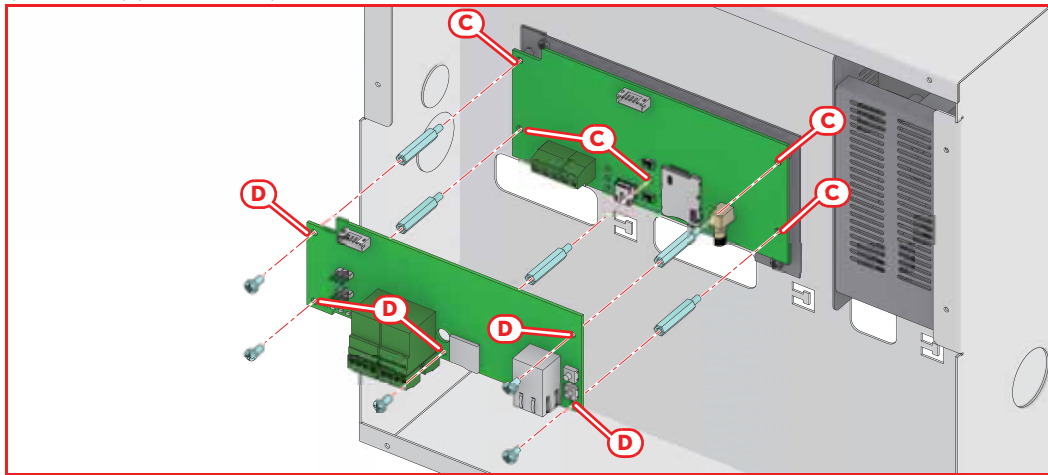

3.3 Control panel wiring

Attention: *Take care to remove all sources of power, including the batteries before starting any wiring operations.*

Note: *The ends of wires must not be soft soldered in points where they are subject to clamping.*

3.3.1 Mains connection

EN54: The power-supply system of Previdia Compact control panels is EN54-4 compliant.

Attention: *Do not power up the system with a non-compliant voltage.*

1. Connect the mains power supply to the terminals on the power-supply module (paragraph 2.2 - [R] and [A]).
For a safety standards compliant system, the Line must be connected to terminal "L", the Neutral conductor to terminal "N".

The power supply to the control panel must come directly from a reserved line of the electric distribution panel. The line must be protected by a sectioning device which complies with local safety regulations, fire codes, laws and bylaws in force.

Note: *As a further safety measure, the electrical system of the building must be protected against overload and short-circuit.*

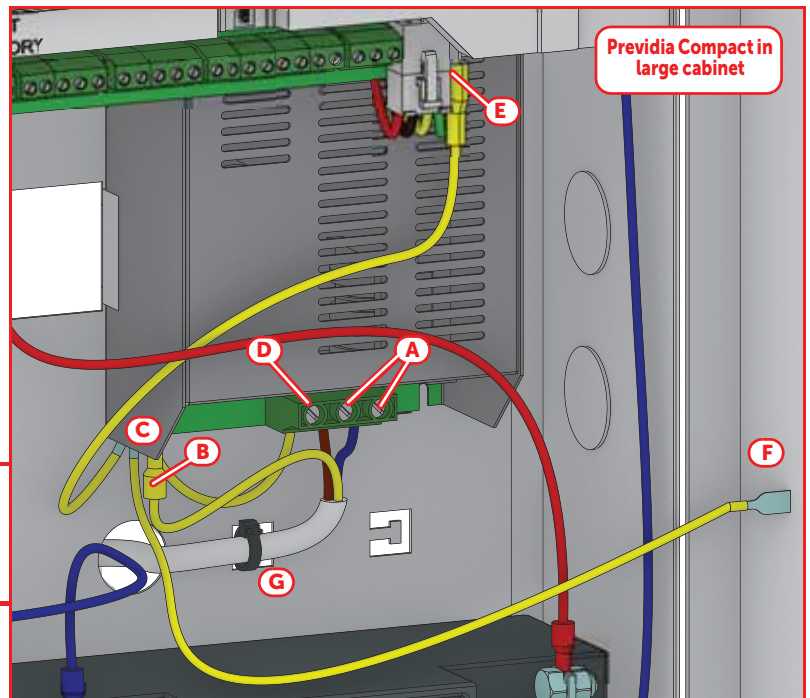

Note: *The end of a stranded wire must not be consolidated with soft soldering in points where the wire is subjected to contact pressure.*

2. Crimp the earth line wire to the eyelet terminal [B].
3. Attach the wire with the eyelet to the control panel using the ground connection screw [C].
4. Ensure that the terminal "⊕" of the power supply module [D], the motherboard [E] and the front plate [F] of the cabinet are connected to earth system.

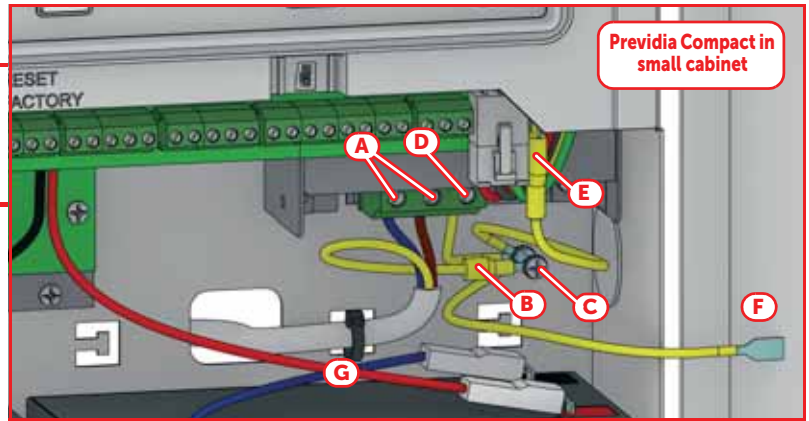

Attention: *The protective earthing system must be compliant with the local safety regulations, fire codes, laws and bylaws in force.*

Note: *A protective earth connection ensures that all exposed conductive surfaces are at the same electrical potential as the earth surface, in order to avoid the risk of electrical shock if a person touches a device in which an insulation fault has occurred. In the event of an insulation fault, a protective earth connection will generate a high fault current which in turn will trigger an overcurrent protection device (fuse) and disconnect the power supply.*

5. Ensure that low-current safety or signal lines DO NOT come into contact with points with potentially dangerous currents.
Using a plastic cable tie, bunch the wires together and secure them to one of the wire hooks on the back of the cabinet [G].

Note: *The connection wires (to the mains supply and also any other wires inside the cabinet) must be secured to the cable hooks on the back plate by means of plastic cable ties. Use cable with double isolation for the connection to the electrical mains.*

3.3.2 Connecting the batteries

The metal cabinet of the control panel provides housing for two 12V, 7 Ah lead batteries for the small version and 17 Ah for the large version. The two batteries must be connected in series, in such way as to supply 24V.

1. Place the batteries into the battery compartment inside the cabinet (paragraph 2.2 - [A1]).
2. Using the battery wire ([A]), connect the batteries together.
3. Connect the wire coming from the power supply ([B] paragraph 2.2 - [U]) to the battery terminals ([C]).

Attention: *Ensure that the polarity is correct.*
Red - positive
Black - negative

The connection of the batteries before the mains voltage is present will not activate the system. Once the mains voltage is supplied, the power-supply module will connect the batteries automatically and initialize the circuits which manage them.

4. Position the thermal probe (paragraph 2.2 - [V]).
The thermal probe must be positioned on the side of the battery and held in place by a strip of tape ([D]).

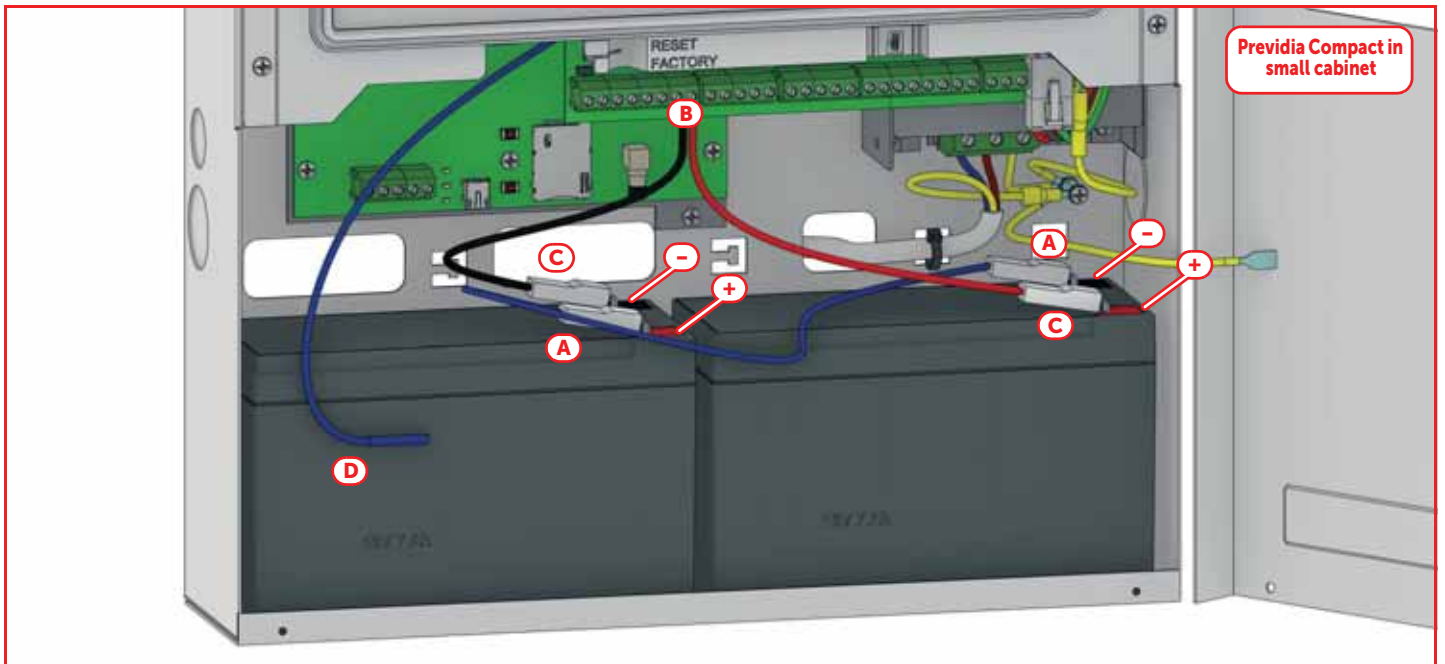
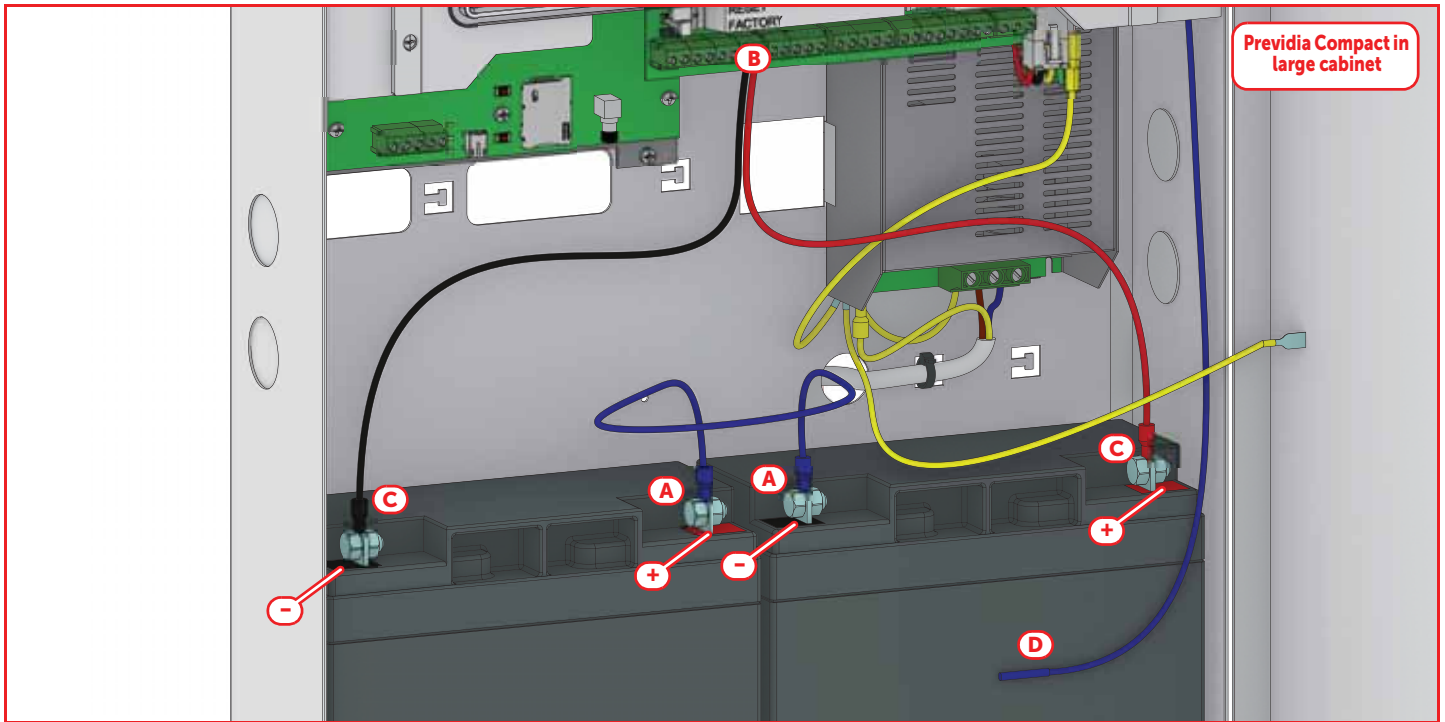

3.4 Connecting the "I/O" terminals

Each of the 4 IN/OUT channels of the control panel (terminals 19-20, 21-22, 23-24, 25-26) can be configured as:

- supervised output
- input

Cables: 2 wire shielded cable
Proper section (minimum 0.5mm², maximum 2.5 mm²)
Compliant with local laws and regulations in force

Connection of polarized devices (sounders, etc.) to channels configured as outputs

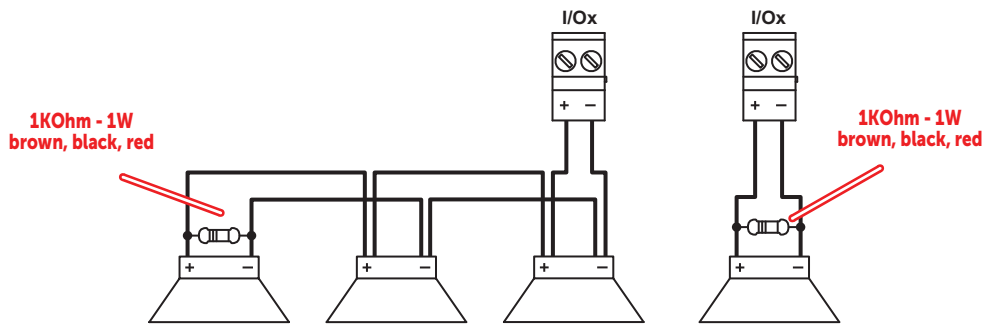

The polarities refer to the active status of the output, the polarities invert for stand-by status.

EN54: If the control panel default settings are left unchanged, the I/O 1 output will result as being configured as a type C output for the connection of audible/visual signalling devices. The output will activate in the event of any type of fire-alarm condition.

Connection of non-polarized devices (relays, etc.) to channels configured as outputs

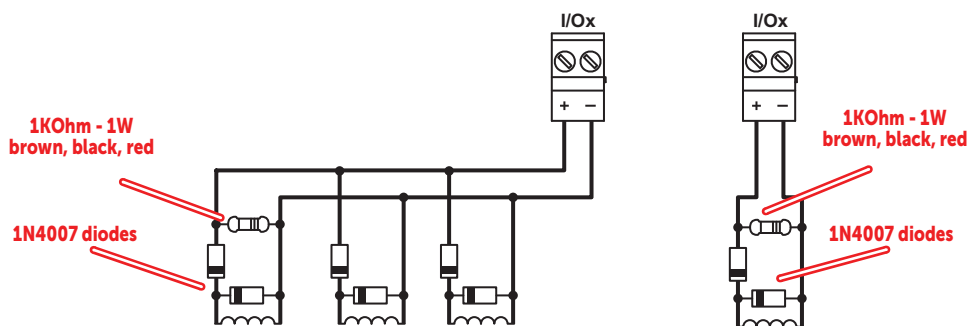

The polarities refer to the active status of the output, the polarities invert for stand-by status.

Connection of devices with an alarm output to channels configured as input

The wiring diagram illustrates a connection made to one of the "I/O" channels [A], configured as input. The connected device [B] is equipped with a normally open output for alarm signalling [C].

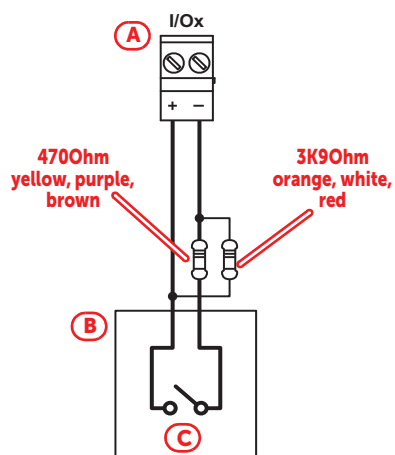

Connection of devices with alarm and fault outputs to channels configured as input

The wiring diagram illustrates a connection made to one of the "I/O" channels [A], configured as input. The connected device [B] is equipped with a normally closed fault signalling output [C] and a normally open alarm signalling output [D].

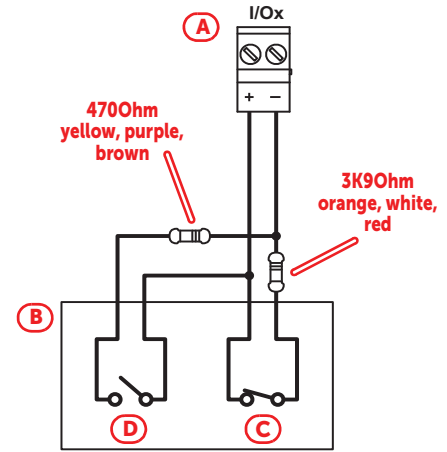

Connection of devices with alarm, early warning and fault outputs to channels configured as input

The wiring diagram illustrates a connection made to one of the "I/O" channels [A], configured as input. The connected device [B] is equipped with a normally-closed fault signalling output [C], a normally-open alarm signalling output [D] and a normally-open early warning signalling output [E].

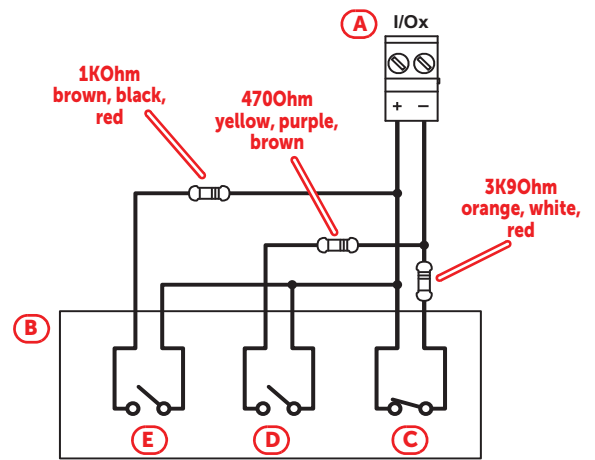

3.5 Relay output wiring

- Cables:** 2/3 wire shielded cable
 Proper section (minimum 0.5mm², maximum 2.5 mm²)
 Compliant with local laws and regulations in force

The relay output of the module (terminals 27-28-29) must be connected according to the following diagram:

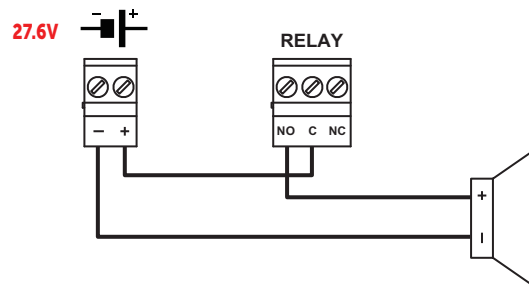

All voltage free relay contact can only be connected to SELV circuits.

The illustrated connection does not supervise the cable and does not signal connection faults.

EN54: If the control panel default settings are left unchanged, the RELAY output will result as being configured as a fault signalling output. In compliance with the regulations in force, the output must be configured as "inverted" in order to switch to fault condition when the system is completely without power. Therefore, in stand-by status (no faults present on the system) terminals C and NO will be closed, whereas terminals C and NC will be open.

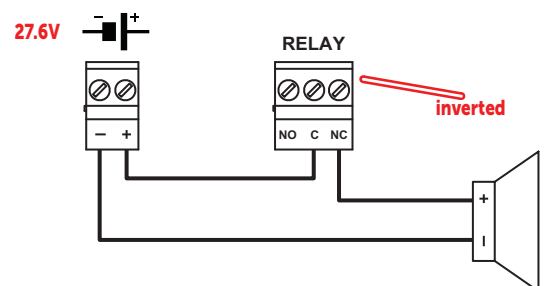

3.6 Loop connections

The connection circuits of the peripheral detection/activation devices are defined as “loops”. These loops start from the output terminals, run through the entire protected area connecting in parallel all the system devices before re-entering on the input terminals.

The loop utilizes the same two wires for the power supply to devices and for two-way communication. Due to electrical incompatibility, devices with different protocols cannot be connected on the same loop. The type of protocol can be set independently for each loop, in such a way as to integrate on the same control panel loop devices of different brands.

Loops are made by means of a two-wire shielded cable with proper wire section (refer to the following cable specifications) and in compliance with local laws in force.

The wiring must be completed in a loop in order to guarantee the tolerance of wire-cutting or short-circuit on the cable.

If you are making a two-wire connection, you can install a maximum of 32 fire-alarm devices on the loop (detectors or call points).

Cables:

2 wire shielded cable
Twisted 5/10cm
Total maximum capacity 0.5uF
Maximum length 2000m
Maximum resistance (considering the sum of the positive and negative conductor) 40Ohm
For a maximum estimate refer to the table below:

Total loop length	Wire section	American Wire Gauge
Up to 1000m	2 x 1 mm ²	17 AWG
Up to 1500m	2 x 1.5 mm ²	16 AWG
Up to 2000m	2 x 2 mm ²	14 AWG

The cable shield must be connected to the earth terminal “⊕” at one end only.

For the connections of the various devices refer to the instructions supplied with the devices themselves.

The following diagram illustrates the proper completion of the loop wiring. Starting from the “Lx O” ((A)) terminals proceed with the connection of the peripheral devices located in the area protected by the system ((B)) and re-enter on terminals “Lx I” ((C)).

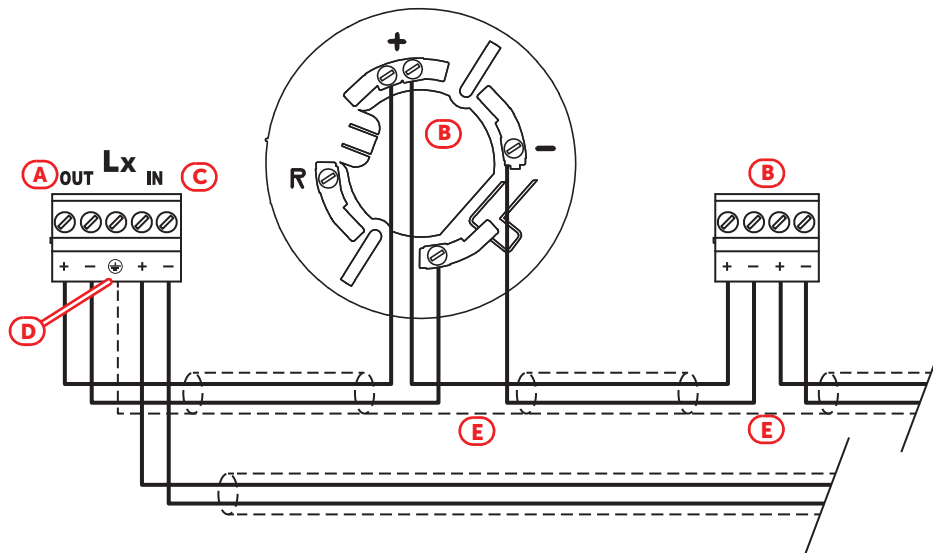

When connecting the loop devices it is not necessary to follow the input/output order indicated in the figure.

Connect the cable shield only to the start-end of the loop ((D)), the shield can be connected to the “⊕” terminal. Be careful to splice appropriately shields that have been cut for device connections ((E)).

3.7 Connecting the Hornet+ network

The connection of two or more control panels (Previdia Max, Previdia Compact or repeaters) in a Hornet+ network can be achieved by using two RS485 communication ports.

Cables: 4 wire shielded cable
 Typical impedance 120Ω
 Maximum length 1000m (between two successive control panels)
 Compliant with local laws and regulations in force

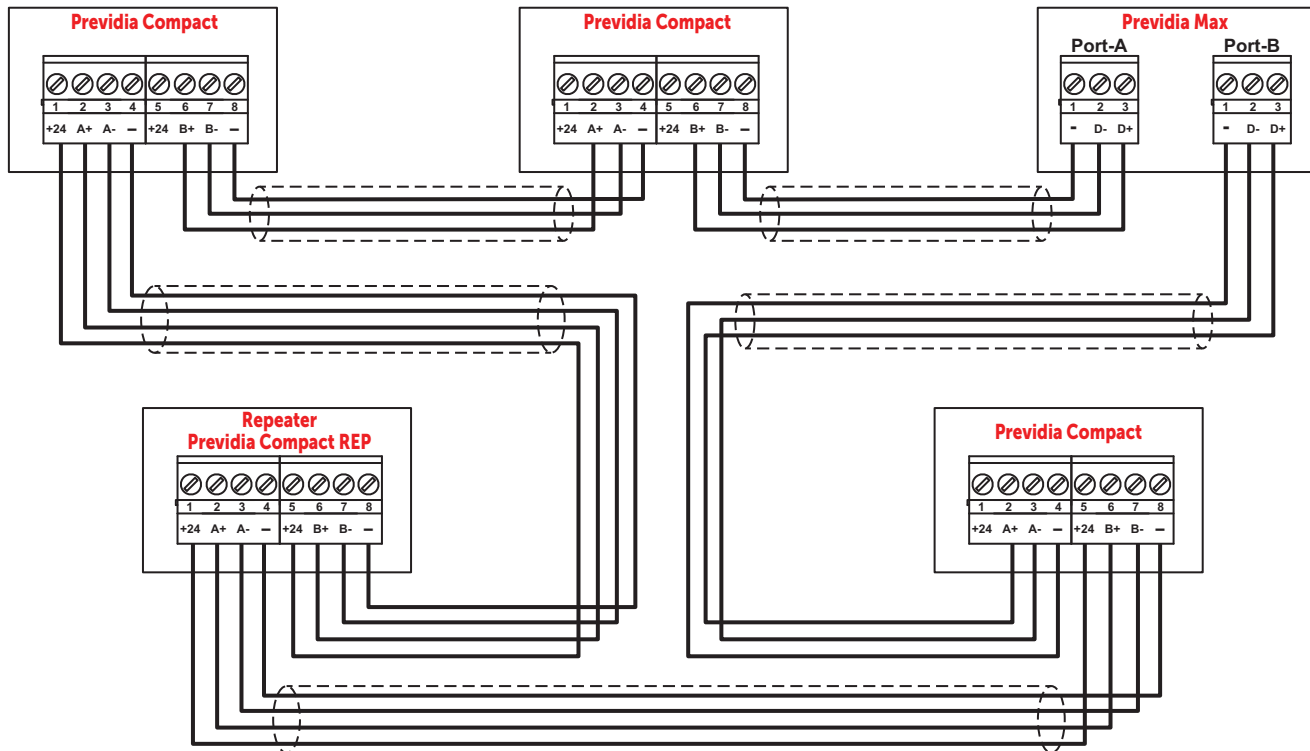

3.8 Connecting the land-line (PSTN)

The control panel can only be connected via the optional Previdia-C-DIAL board.

Cables: Compliant with local regulations in force

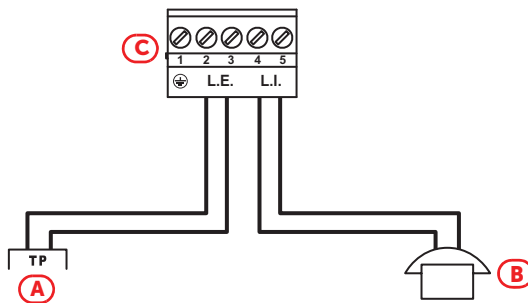

Connect the telephone line [A] to the "L.E." terminals and telephone device or the internal phone line [B] to the "L.I." terminals of the board ([C], paragraph 2.4 - [B]).

3.9 Wiring the external communicators

The Previdia Compact control panels can be used to drive remote alarm or fault signalling devices

Cables: 2-wire shielded cable
 Proper section (minimum 0.5mm², maximum 2.5 mm²)
 Compliant with local laws and regulations in force

The "I/O" terminals on-board the control panel [A] and the outputs supervised on the loop modules can be used to create an E-type output (output for the activation of alarm signalling on a remote signalling device, as prescribed by standard EN54-2).

To create a J type output (output for activation of fault status signalling on a remote signalling device, as prescribed by standard EN54-2), only the "I/O" terminals can be used on board the control unit, which can be Programmed as active in rest condition.

EN54:

In both cases, as the external communicator, you must use a remote communication device compliant with standard EN54-21 [B] and equipped with a supervised activation input [C], a normally closed fault signal output [D] and a normally-open output for confirming successful communications [E].

If the external Communicator does not have a supervised activation input, the connection to the control panel can be carried out by means of a relay, which must be installed inside the communicator casing. To transmit alarm events via the I/O terminals on board the control panel, you can use normal wiring for non-polarized devices. To transmit failure events, use the following wiring diagram:

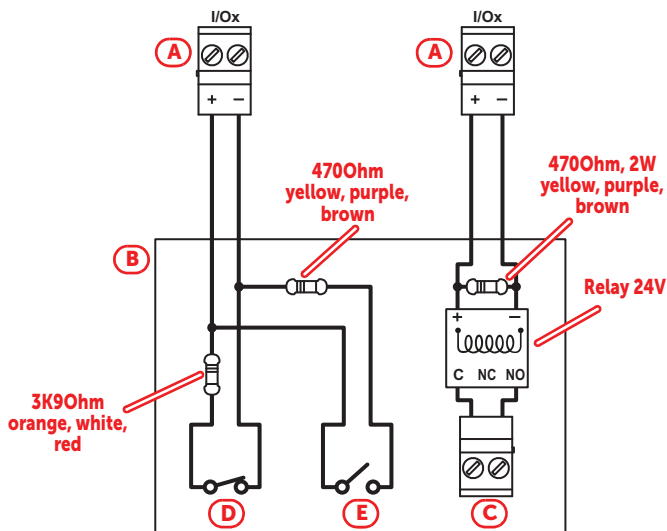

System test

INIM Electronics recommends that the entire system be checked completely at regular intervals.

For the instructions for system testing and maintenance refer to the *Manual for system configuration, commissioning and maintenance*.

Replacement and disposal of used devices

When replacing obsolete devices, disconnect the devices concerned then complete the connections of the new devices in compliance with the instructions printed on the respective leaflets.

Contact your local municipal offices for information regarding the disposal of used electronic devices.

Do not burn used electronic devices, or allow them to pollute the environment (countryside, rivers, etc.). Electronic devices must be disposed of in a safe environment-friendly way. In order to avoid short-circuits, take all the necessary precautions when removing used batteries.

WEEE

Informative notice regarding the disposal of electrical and electronic equipment (applicable in countries with differentiated waste collection systems)



The crossed-out bin symbol on the equipment or on its packaging indicates that the product must be disposed of correctly at the end of its working life and should never be disposed of together with general household waste.

The user, therefore, must take the equipment that has reached the end of its working life to the appropriate civic amenities site designated to the differentiated collection of electrical and electronic waste. As an alternative to the autonomous-management of electrical and electronic waste, you can hand over the equipment you wish to dispose of to a dealer when purchasing new equipment of the same type. You are also entitled to convey for disposal small electronic-waste products with dimensions of less than 25cm to the premises of electronic retail outlets with sales areas of at least 400m², free of charge and without any obligation to buy.

Appropriate differentiated waste collection for the subsequent recycling of the discarded equipment, its treatment and its environmentally compatible disposal helps to avoid possible negative effects on the environment and on health and favours the re-use and/or recycling of the materials it is made of.



ISO 9001 Quality Management
certified by BSI with certificate number FM530352

Centobuchi, via Dei Laboratori 10
63076 Montepredone (AP) Italy
Tel. +39 0735 705007 _ Fax +39 0735 704912

info@inim.biz _ www.inim.biz



DCMIINEOPREVIDIAC-110-20200114